

U.Beams

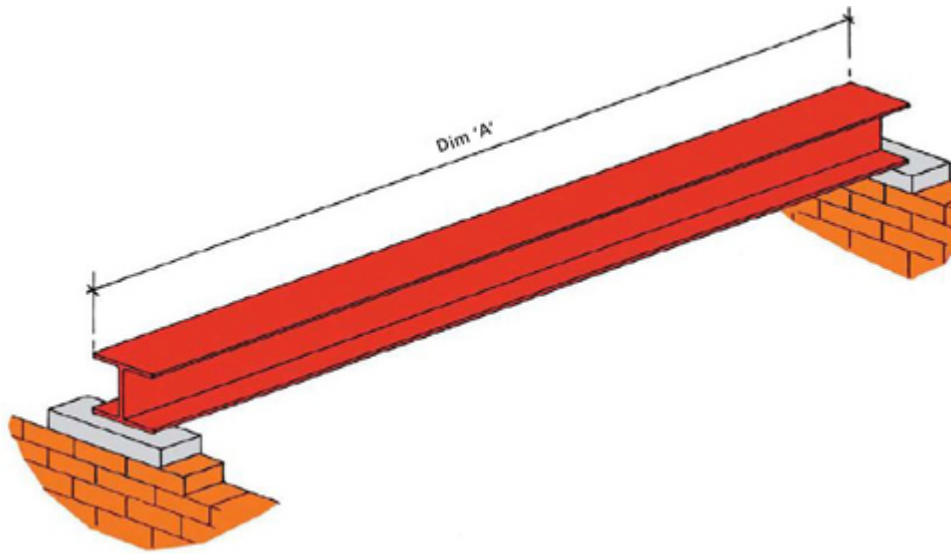

REF. '1' THROUGH WEB

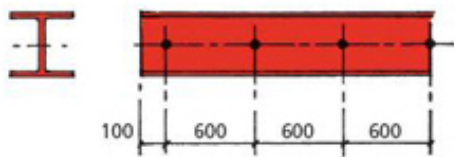

REF. '2' THROUGH TOP FLANGE

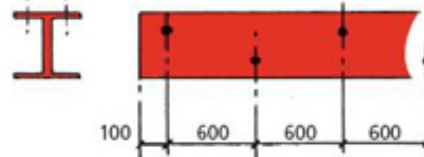

REF. '4' DRAG CLEATS



REF. '3' HOLD DOWN BOLTS

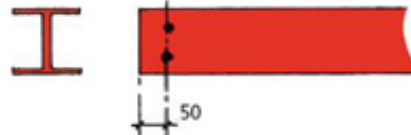

Channels

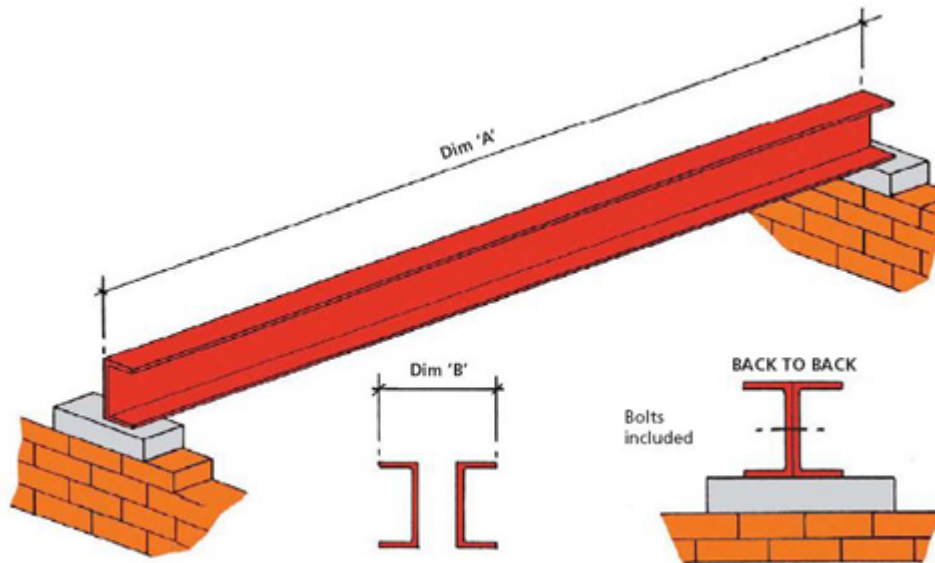

REF. '1' TUBULAR SPACES

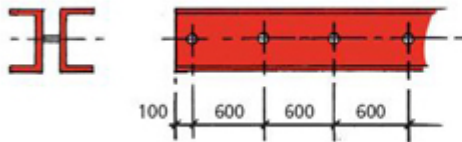

REF. '2' THROUGH TOP FLANGE

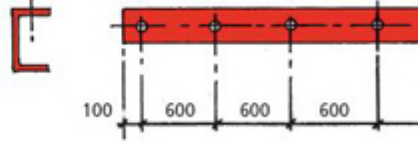

REF. '4' CHANNEL SPACERS

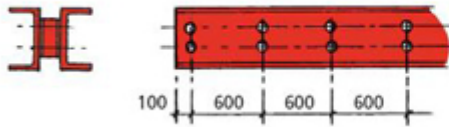

REF. '3' HOLD DOWN BOLTS



Double Beams

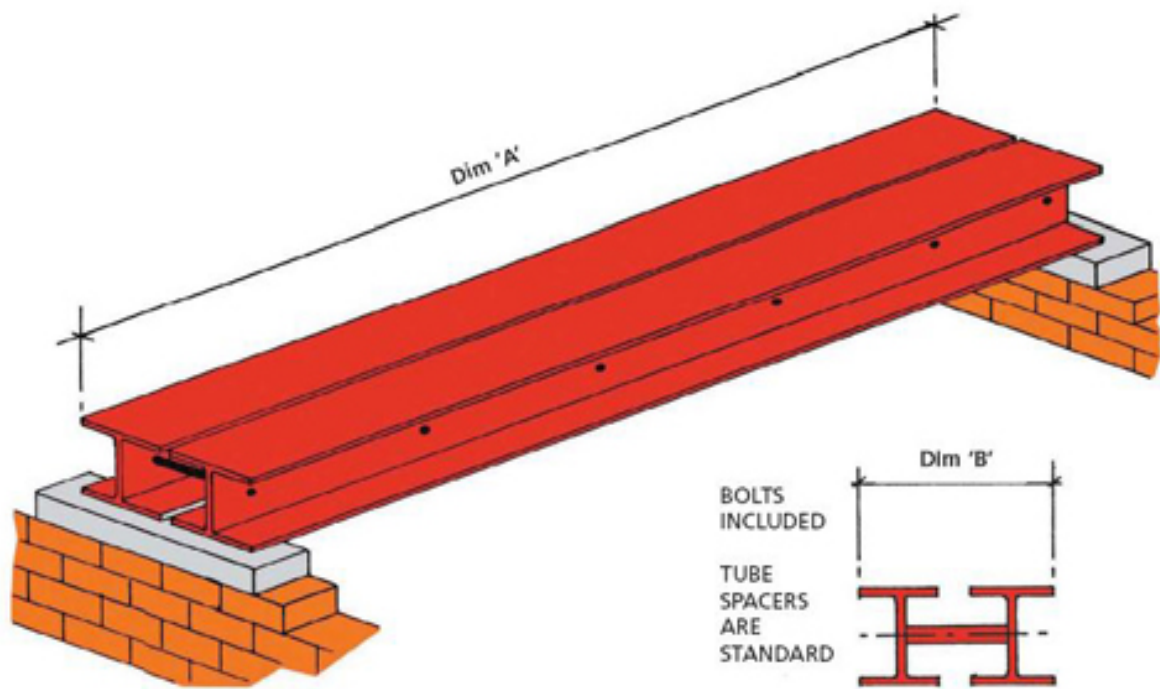

REF. '1' CHANNEL SPACERS

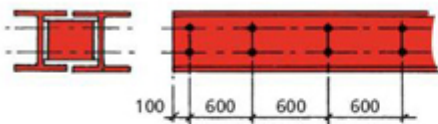

REF. '2' THROUGH TOP FLANGE

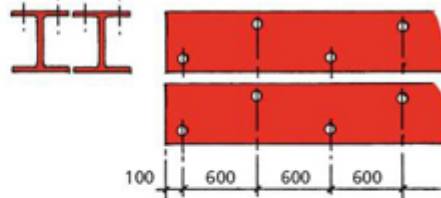

REF. '1' DRAG CLEATS



REF. '2' HOLD DOWN BOLTS

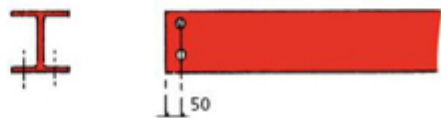

Tee Beams

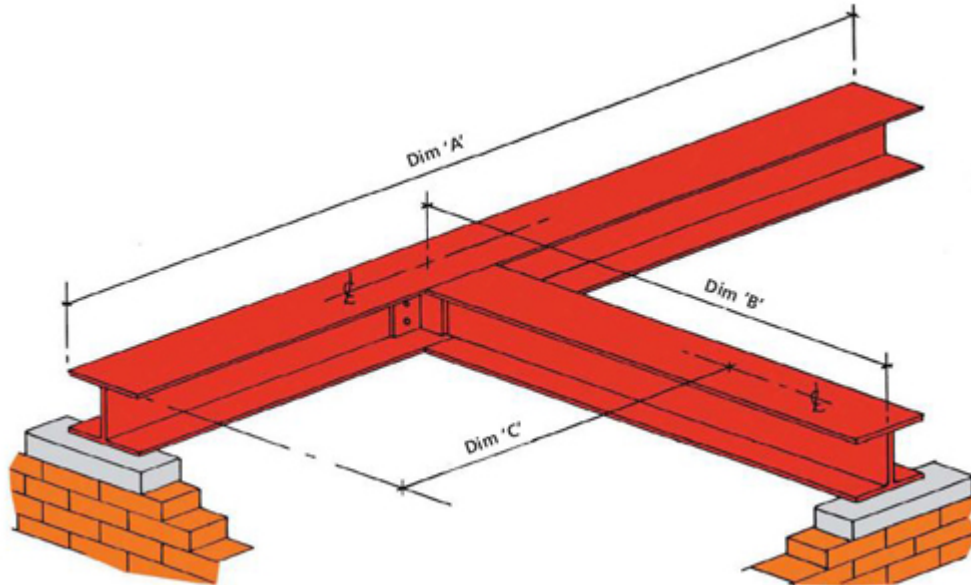

REF. '1' THROUGH WEB

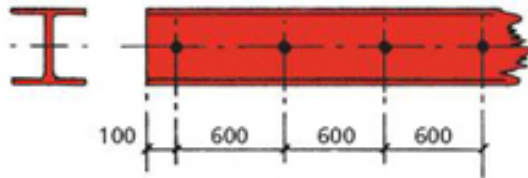

REF. '2' THROUGH TOP FLANGE

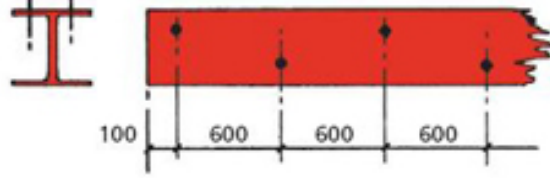

REF. '4' DRAG CLEATS



REF. '3' HOLD DOWN BOLTS



Spliced Beams

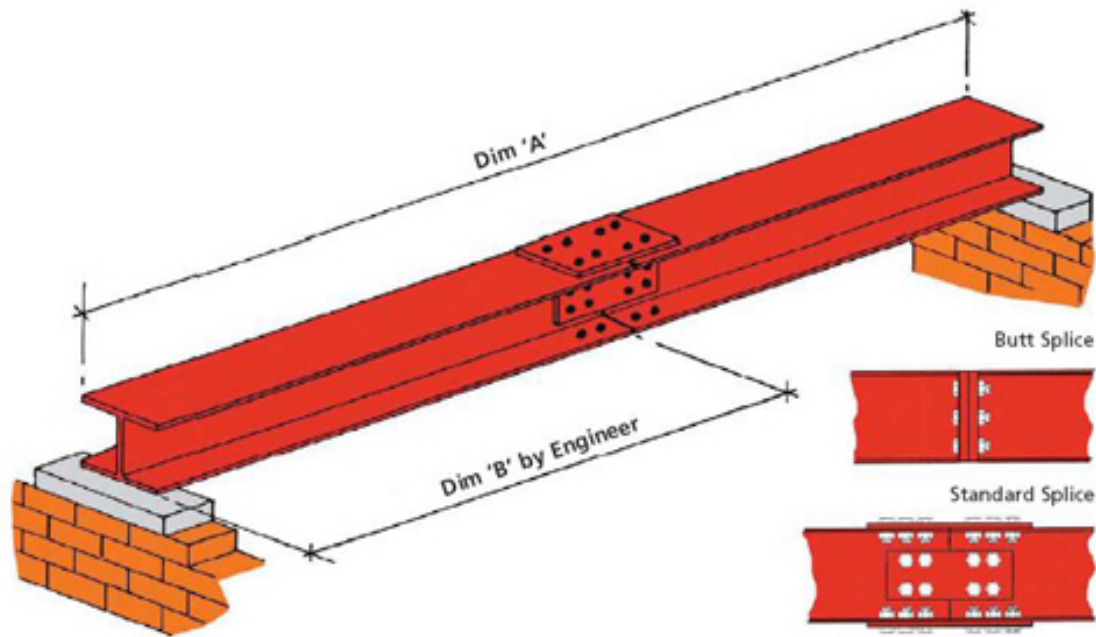

REF. '1' THROUGH WEB

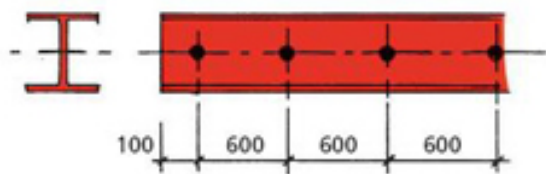

REF. '2' THROUGH TOP FLANGE

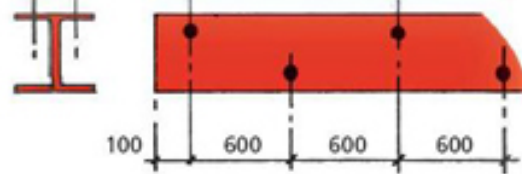

REF. '4' DRAG CLEATS



REF. '3' HOLD DOWN BOLTS

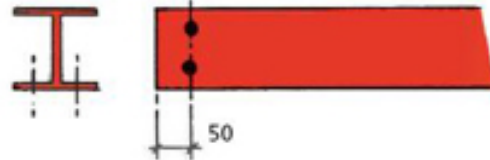

Fitch Beams

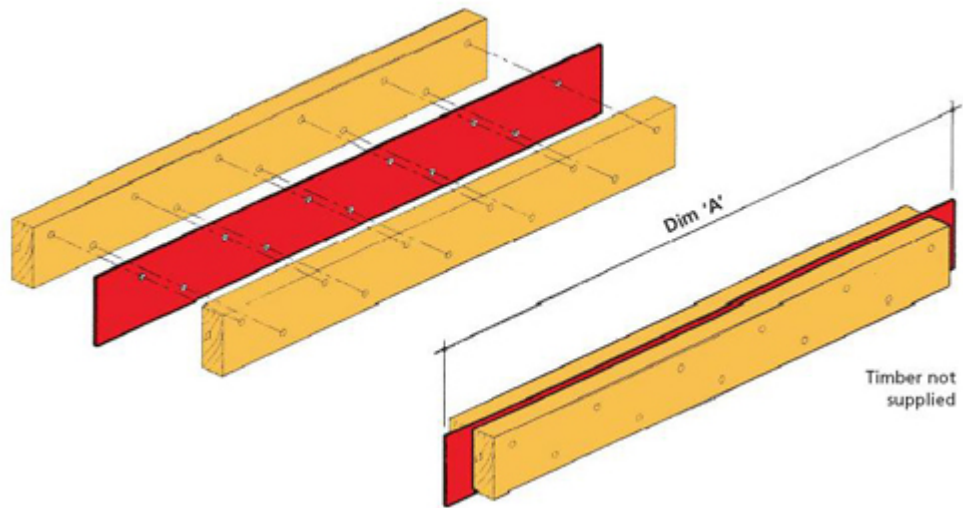

REF. '1' CENTRE LINE

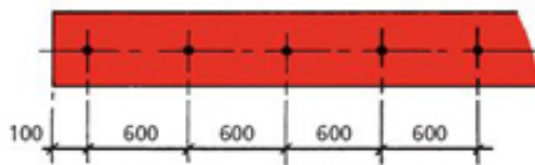

REF. '2' STAGGERED

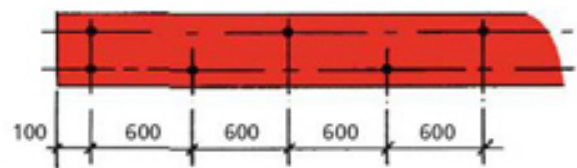

Cranked Beams

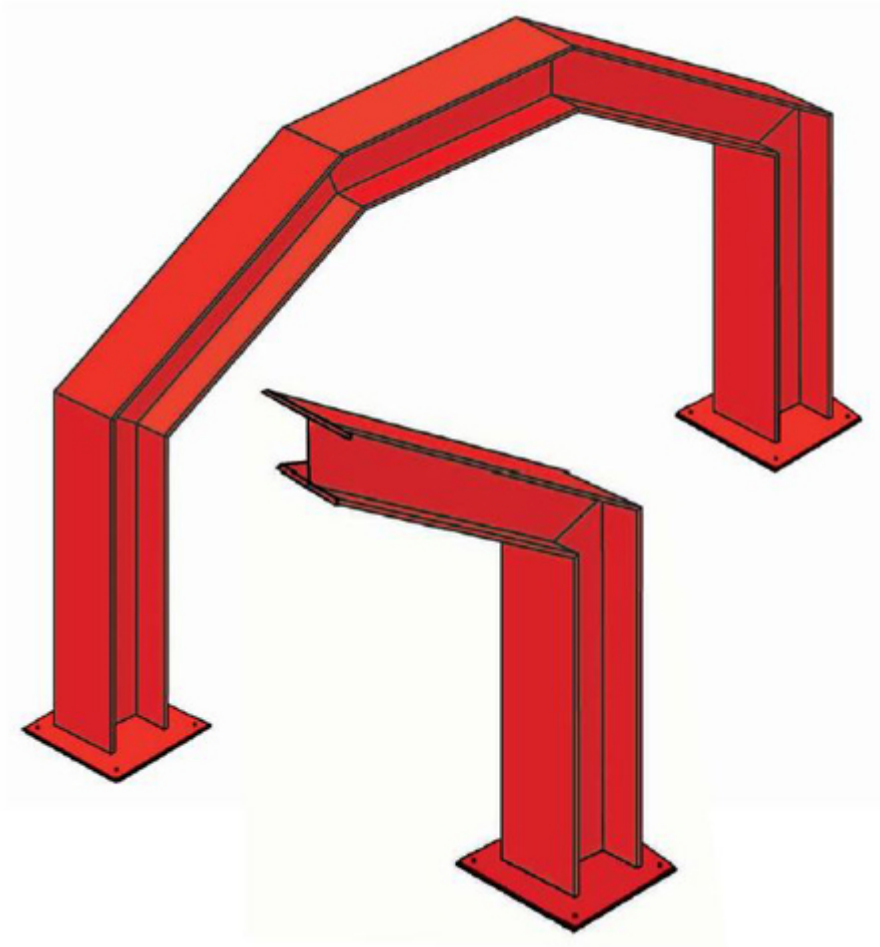

REF. '1' THROUGH WEB

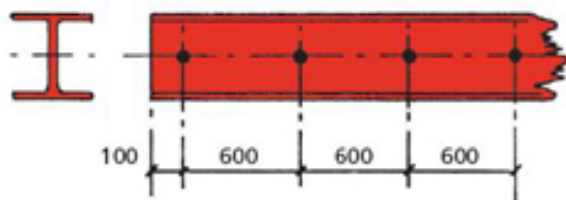

REF. '2' THROUGH TOP FLANGE

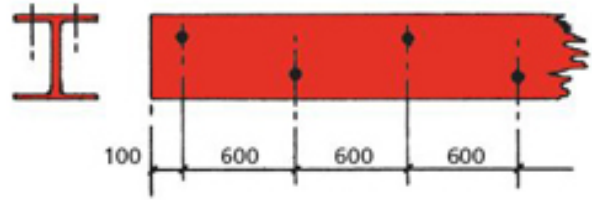

Brackets and Cleats

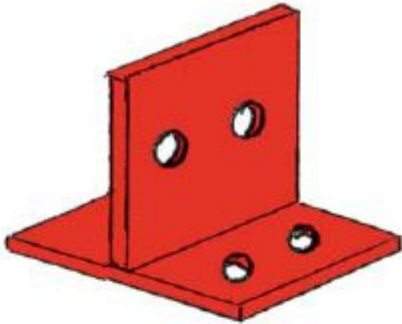

TEE BRACKETS

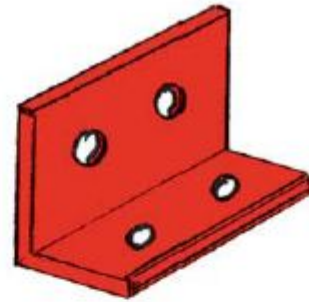

CLEATS

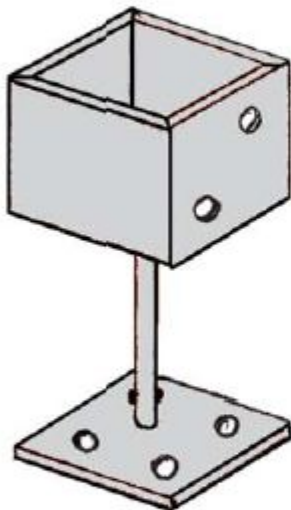

POST SHOES

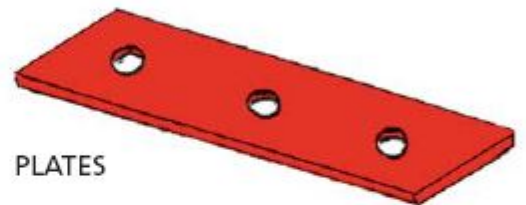

PLATES

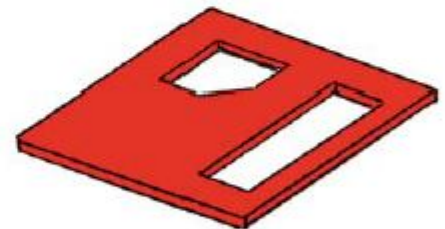

LASER CUTTING

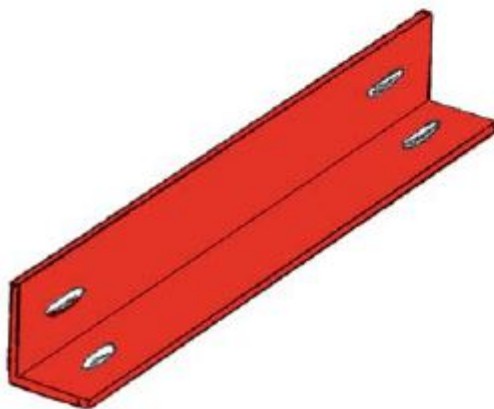

ANGLES

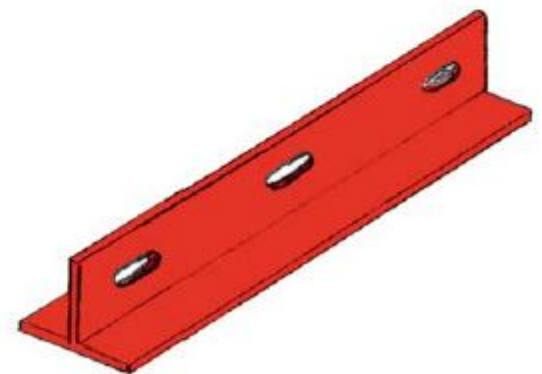

SPLIT TEES

Heavy Duty Beams

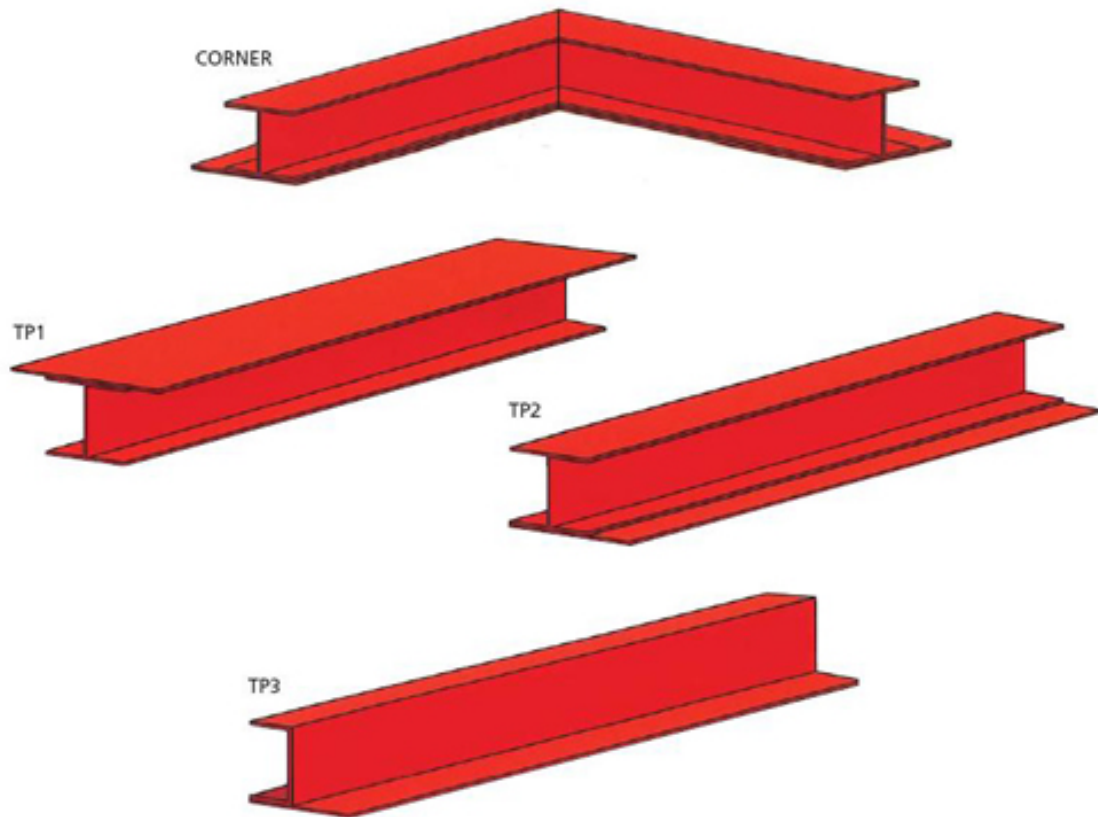

REF. '1' THROUGH WEB

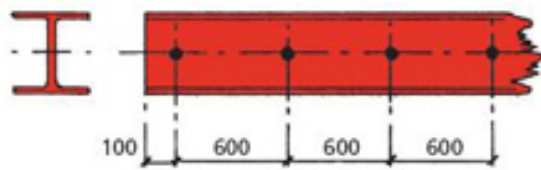

REF. '3' HOLD DOWN BOLTS

